

ADA Checklist for Readily Achievable Barrier Removal

Priority 4 – Additional Access

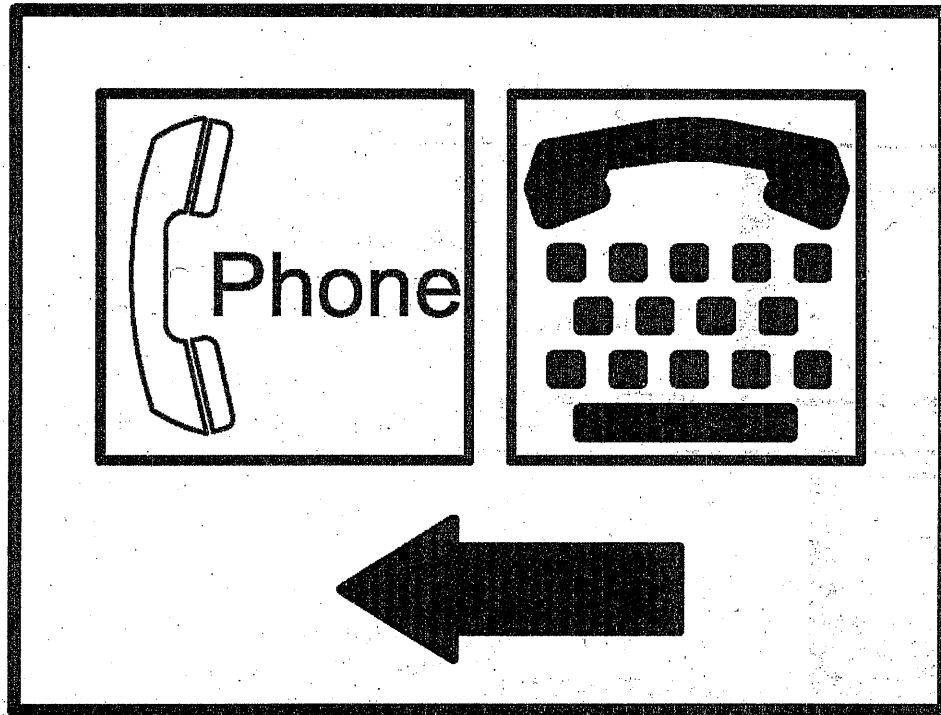

Project

Building James Kennedy Public Library

Location Dyersville, IA

Date 2-12-19

Surveyors Shirley Vonderhaar

Contact Information 563-875-8912

svonderhaar@dyersville.lib.ia.us

Amenities such as drinking fountains and public telephones should be accessible to people with disabilities.



Institute for Human Centered Design
www.HumanCenteredDesign.org

November 2011



ADA National Network
Questions on the ADA 800-949-4232 voice/tty
www.ADAchecklist.org



This checklist was produced by the New England ADA Center, a project of the Institute for Human Centered Design and a member of the ADA National Network. This checklist was developed under a grant from the Department of Education, NIDRR grant number H133A060092-09A. However the contents do not necessarily represent the policy of the Department of Education, and you should not assume endorsement by the Federal Government.

Questions or comments on the checklist contact the New England ADA Center at 617-695-0085 voice/tty or ADAinfo@NewEnglandADA.org

For the full set of checklists, including the checklists for recreation facilities visit www.ADAchecklist.org.

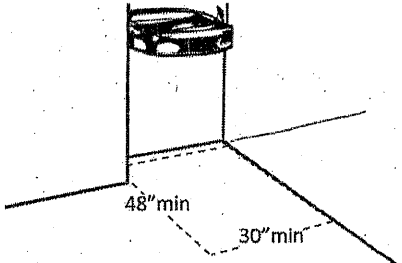
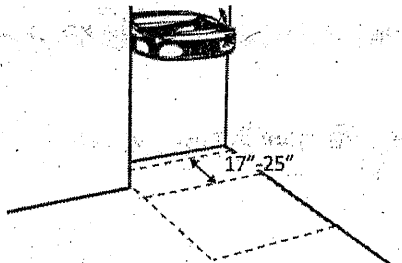
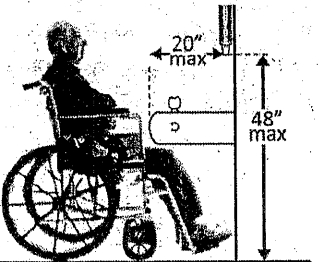
| Priority 4 – Additional Access | | Comments | Possible Solutions |
|---|---|--|---|
| Drinking Fountains (2010 Standards – 602) | | | |
| <p>4.1 Does at least one drinking fountain have a clear floor space at least 30 inches wide x at least 48 inches long centered in front of it for a forward approach?*</p> | <p><input checked="" type="checkbox"/> Yes <input type="checkbox"/> No</p> <p>Measurement: <i>Open in all directions.</i></p> |  <p>48" min 30" min</p> | <p>*If installed before 3/15/2012, a parallel approach is permitted and the clear floor space is not required to be centered</p> <ul style="list-style-type: none"> • Alter space • Relocate drinking fountain • Install a drinking fountain in another location |
| <p>4.2 If there is a forward approach, do no less than 17 inches and no greater than 25 inches of the clear floor space extend under the drinking fountain?</p> | <p><input checked="" type="checkbox"/> Yes <input type="checkbox"/> No</p> <p>Measurement: <i>18 1/2"</i></p> |  <p>17"-25"</p> | <ul style="list-style-type: none"> • Alter space • Replace drinking fountain • |
| <p>4.3 If the drinking fountain is no deeper than 20 inches, are the operable parts no higher than 48 inches above the floor?</p> | <p><input checked="" type="checkbox"/> Yes <input type="checkbox"/> No</p> <p>Measurement: <i>30"</i></p> |  <p>20" max 48" max</p> | <ul style="list-style-type: none"> • Adjust drinking fountain • Replace drinking fountain • |

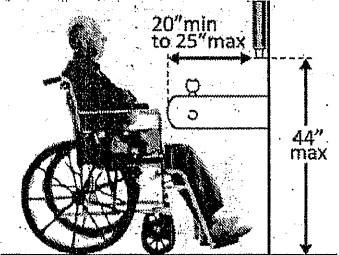
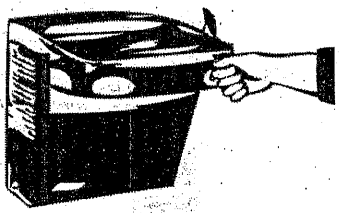
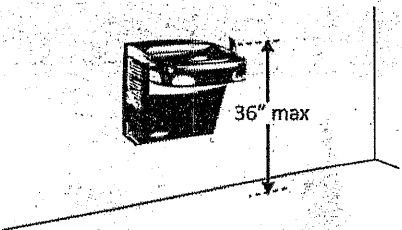
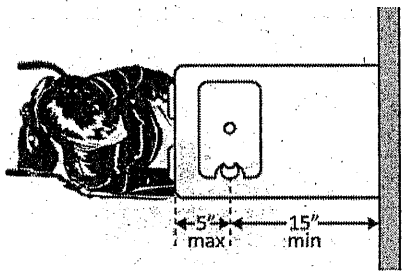

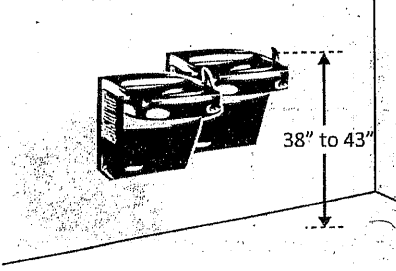
| | | | |
|--|--|--|--|
| <p>4.4 If the drinking fountain is no less than 20 inches and no greater than 25 inches deep, are the operable parts no higher than 44 inches above the floor?</p> | <p><input checked="" type="checkbox"/> Yes <input type="checkbox"/> No</p> <p>Measurement: 32"</p> |  | <p>Photo #:</p> <ul style="list-style-type: none"> • Adjust drinking fountain • Replace drinking fountain • |
| <p>4.5 Can the control be operated with one hand and without tight grasping, pinching or twisting of the wrist?</p> <p>Is the force required to activate the control no more than 5 pounds?</p> | <p><input checked="" type="checkbox"/> Yes <input type="checkbox"/> No</p> <p><input checked="" type="checkbox"/> Yes <input type="checkbox"/> No</p> <p>Measurement:</p> |  | <p>Photo #:</p> <ul style="list-style-type: none"> • Change control • Adjust control • |
| <p>4.6 Is the spout outlet no higher than 36 inches above the floor?</p> | <p><input checked="" type="checkbox"/> Yes <input type="checkbox"/> No</p> <p>Measurement: 36"</p> |  | <p>Photo #:</p> <ul style="list-style-type: none"> • Adjust drinking fountain • Replace drinking fountain • |
| <p>4.7 Is the spout:</p> <p>At least 15 inches from the rear of the drinking fountain?</p> <p>No more than 5 inches from the front of the drinking fountain?</p> | <p><input checked="" type="checkbox"/> Yes <input type="checkbox"/> No</p> <p>Measurement: 16"</p> <p><input checked="" type="checkbox"/> Yes <input type="checkbox"/> No</p> <p>Measurement: 2 1/2"</p> |  | <p>Photo #:</p> <ul style="list-style-type: none"> • Adjust spout • Replace drinking fountain • |

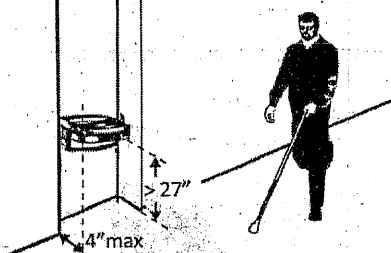

| | | | | | |
|---|--|---|--|-----------------|---|
| <p>4.8</p> <p><i>Only one fountain NA</i></p> | <p>If there is more than one drinking fountain, is there at least one for standing persons?</p> <p>Is the spout outlet no lower than 38 inches and no higher than 43 inches above the floor?</p> | <p><input type="checkbox"/> Yes <input type="checkbox"/> No</p> <p><input type="checkbox"/> Yes <input type="checkbox"/> No</p> <p>Measurement:</p> |  | <p>Photo #:</p> | <ul style="list-style-type: none"> • Adjust drinking fountain • Install new drinking fountain for standing height |
|---|--|---|--|-----------------|---|

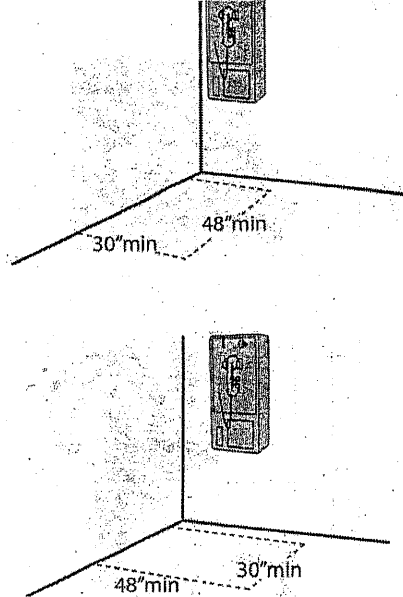
| | | | | | |
|------------|--|---|--|-----------------|---|
| <p>4.9</p> | <p>If the leading (bottom) edge of the fountain is higher than 27 inches above the floor, does the front of the fountain protrude no more than 4 inches into the circulation path?</p> | <p><input type="checkbox"/> Yes <input type="checkbox"/> No</p> <p>Measurement:</p> |  | <p>Photo #:</p> | <ul style="list-style-type: none"> • Adjust drinking fountain • Replace drinking fountain • Add tactile warning such as permanent planter or partial walls |
|------------|--|---|--|-----------------|---|

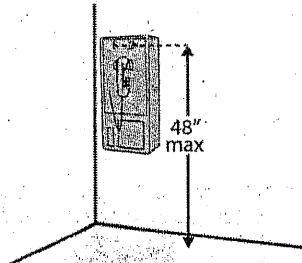
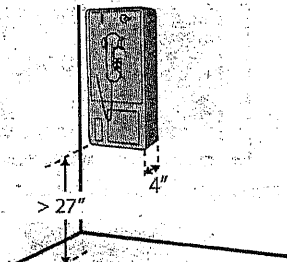
Public Telephones (2010 Standards – 704) TTY's are devices that employ interactive text-based communication through the transmission of coded signals across the telephone network. They are mainly used by people who are deaf and/or cannot speak.

| | | | | | |
|--|---|--|---|-----------------|---|
| <p>4.10</p> <p><i>phone is located on circulation desk</i></p> | <p>Does at least one telephone have a clear floor space at least 30 inches wide x at least 48 inches long for a parallel or forward approach?</p> | <p><input checked="" type="checkbox"/> Yes <input type="checkbox"/> No</p> |  | <p>Photo #:</p> | <ul style="list-style-type: none"> • Move telephone • Install new telephone for clear floor space |
|--|---|--|---|-----------------|---|

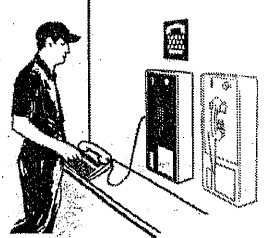
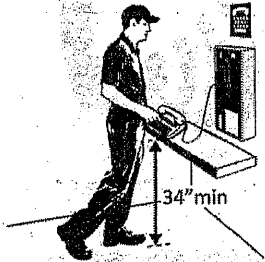
| | | | | |
|--|--|--|-----------------|--|
| <p>4.11 Is the highest operable part of the telephone no higher than 48 inches above the floor?</p> | <p><input checked="" type="checkbox"/> Yes <input type="checkbox"/> No</p> <p>Measurement: 45"</p> |  | <p>Photo #:</p> | <ul style="list-style-type: none"> • Adjust telephone • • |
| <p>4.12 If the leading (bottom) edge of the telephone is higher than 27 inches above the floor, does the front of the telephone protrude no more than 4 inches into the circulation path?</p> | <p><input checked="" type="checkbox"/> Yes <input type="checkbox"/> No</p> <p>Measurement: Located on desk</p> |  | <p>Photo #:</p> | <ul style="list-style-type: none"> • Adjust telephone • • |
| <p>4.13 Does at least one telephone have a volume control?</p> | <p><input checked="" type="checkbox"/> Yes <input type="checkbox"/> No</p> |  | <p>Photo #:</p> | <ul style="list-style-type: none"> • Install volume control • Replace telephone with one that has volume control • |
| <p>4.14 Is the volume control identified by a pictogram of a telephone handset with radiating sound waves?</p> | <p><input type="checkbox"/> Yes <input checked="" type="checkbox"/> No</p> |  | <p>Photo #:</p> | <ul style="list-style-type: none"> • Add pictogram • • <p>phones will be changing when partner with city will add them.</p> |

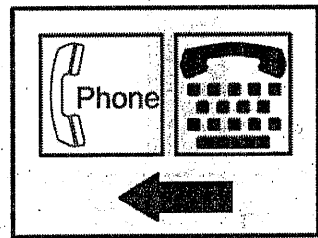
| | | | | |
|--|--|--|-----------------|---|
| <p>4.15 Does at least one telephone have a TTY? <i>No</i></p> | <p><input type="checkbox"/> Yes <input checked="" type="checkbox"/> No</p> |  | <p>Photo #:</p> | <ul style="list-style-type: none"> • Install TTY • • |
| <p>4.16 Is the touch surface of the TTY keypad at least 34 inches above the floor? <i>NA</i></p> | <p><input type="checkbox"/> Yes <input type="checkbox"/> No Measurement:</p> |  | <p>Photo #:</p> | <ul style="list-style-type: none"> • If a seat is provided, TTY is not required to be 34 inches minimum above the floor • Adjust height of TTY • |
| <p>4.17 Is the TTY identified by the International Symbol of TTY? <i>NA</i></p> | <p><input type="checkbox"/> Yes <input type="checkbox"/> No</p> |  | <p>Photo #:</p> | <ul style="list-style-type: none"> • Add symbol • • |
| <p>4.18 Do signs that provide direction to public telephones also provide direction to the TTY? <i>NA</i></p> | <p><input type="checkbox"/> Yes <input type="checkbox"/> No</p> |  | <p>Photo #:</p> | <ul style="list-style-type: none"> • Add signs • • |

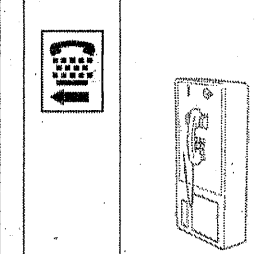
| | | | | |
|--|--|--|-----------------|---|
| <p>4.19 Do telephones that do not have a TTY provide direction to the TTY?</p> | <p><input type="checkbox"/> Yes <input checked="" type="checkbox"/> No</p> |  | <p>Photo #:</p> | <ul style="list-style-type: none"> • Add signs • • |
|--|--|--|-----------------|---|

Fire Alarm Systems (2010 Standards – 702)

| | | | | |
|---|--|--|-----------------|---|
| <p>4.20 If there are fire alarm systems, do they have both flashing lights and audible signals?</p> | <p><input checked="" type="checkbox"/> Yes <input type="checkbox"/> No</p> |  | <p>Photo #:</p> | <ul style="list-style-type: none"> • Install audible and visual alarms • • |
| | <p><input type="checkbox"/> Yes <input type="checkbox"/> No</p> | | <p>Photo #:</p> | <ul style="list-style-type: none"> • • • |
| | <p><input type="checkbox"/> Yes <input type="checkbox"/> No</p> | | <p>Photo #:</p> | <ul style="list-style-type: none"> • • • |
| | <p><input type="checkbox"/> Yes <input type="checkbox"/> No</p> | | <p>Photo #:</p> | <ul style="list-style-type: none"> • • • |

